

ISP360

Profiling Sonar

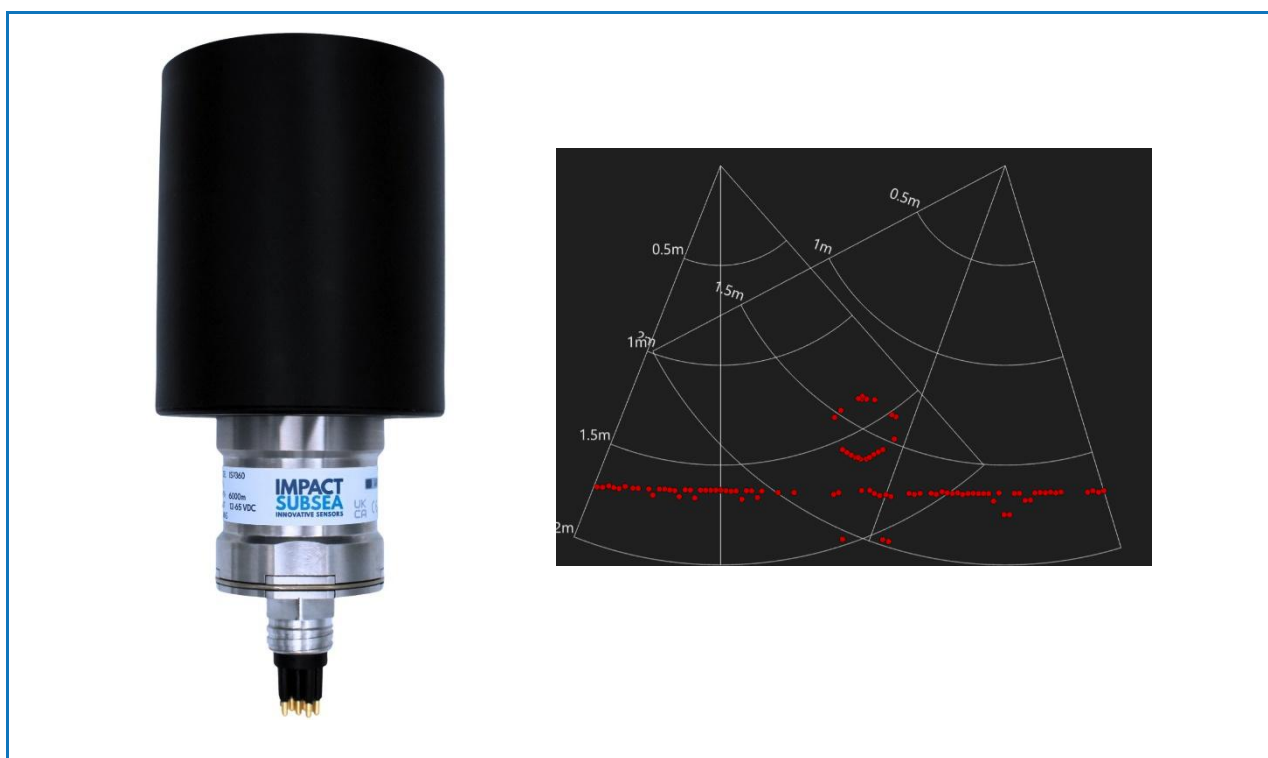

Installation & Operation Manual

Revision Number:	1.2
Date	13 th March 2025

Contents

1.0 Introduction	4
2.0 ISP360 Specification	5
2.1 Overview	5
2.2 Dimensions.....	5
2.3 Acoustic & Attitude	6
2.4 Communication, Power & Physical	6
2.5 Acoustic Beam Pattern	7
3.0 Installation.....	8
3.1 Electrical Installation	8
3.1.1 Connector Pin Out.....	8
3.1.2 Power	9
3.1.3 Serial Interface	9
3.1.4 RS232 Wiring.....	9
3.1.5 RS485 Wiring.....	10
3.1.6 Ethernet Wiring.....	10
3.1.7 Establishing Communications	11
3.1.8 Connector Mating	11
3.1.9 Connector Cleaning.....	12
3.2 Installation Location	12
3.2.1 Acoustics (Profiling Performance).....	12
3.2.2 Alignment with Vehicle	13
3.3 Mounting.....	14
4.0 Operation	16
4.1 Use with seaView Software.....	16
4.1.1 Initial Connection	17
4.1.2 ISP360 Profiler Application.....	18
4.1.3 ISP360 Operational Settings.....	23
4.1.6 Other Settings & Logging	28
4.1.7 Data Output to Survey / Custom Log File.....	33
4.1.8 ISP360 Acoustic Advanced Features	34
4.1.9 Hot Keys	34
5.0 Maintenance & Servicing	35
6.0 Output Strings	36

7.0 Theory of Operation.....	37
7.1 Sonar – Basic Principles.....	37
7.2 The Sonar Equation	39
7.2.1 Source Level (SL)	39
7.2.2 Transmission Loss (TL).....	40
7.2.3 Noise Level (NL).....	40
7.2.4 Directional Index (DI)	41
7.2.5 Detection Threshold (DT)	41
8.0 Warranty	42
9.0 Technical Support.....	43

1.0 Introduction

The ISP360 profiling sonar provides between a 1° and 2° acoustic angular resolution, 0.35mm timing accuracy and up to 80 meter / 262 feet distance measurement capability.

The ISP360 is a new generation of mechanically scanned profiling sonar, providing high accuracy profiling in a very compact form.

As a very compact profiling sonar, the ISP360 is an ideal survey profiler for the smallest to the largest underwater vehicles.

Provided with a titanium housing the ISP360 is depth rated to 4,000 meters / 13,123 feet.

The ISP360 is optionally available with an integrated Attitude Reference System (ARS). This provides highly stable Pitch and Roll readings.

A broadband composite transducer coupled with the Impact Subsea Signalling Scheme (**IS³**) enables excellent performance.

Each profiler provides a full 360° field of vision produced by a mechanically scanned transducer. This field of vision can be narrowed to any start and stop angle as defined by the operator. The transducer utilises inductive coupling to the sonar electronics which enables operation without the use of slip rings. This ensures excellent longevity in operation.

All profiler settings are fully software configurable using the seaView software. The ISP360 Profiler application within seaView is highly intuitive; ensuring distance measurement range, angular step resolution and other settings can quickly and easily be adjusted by the user.

As an alternative to the seaView software, a software development kit is available for third party integration and interface development.



ISP360 Profiling Sonar

2.0 ISP360 Specification

2.1 Overview



Above: ISP360 Profiler

2.2 Dimensions

The dimensions of the ISP360 profiler are shown below:

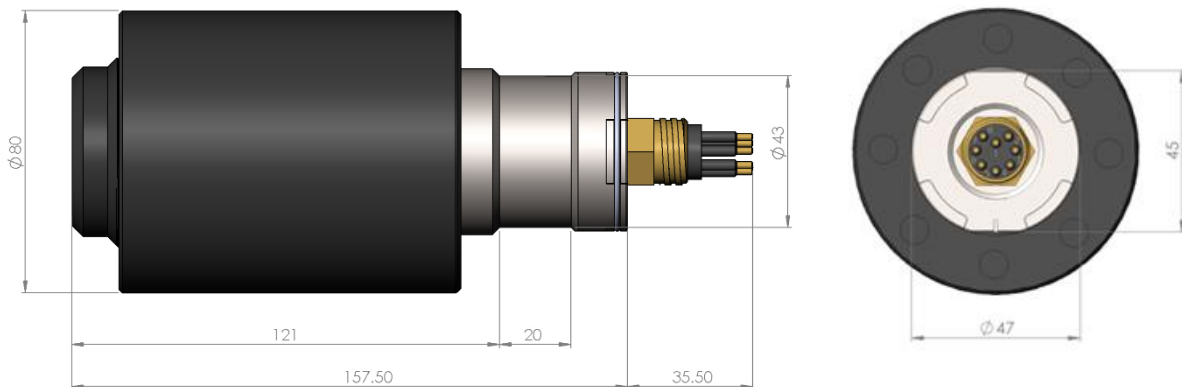

All dimensions are in mm.

2.3 Acoustic & Attitude

Acoustic		Attitude	
Frequency	950kHz Centre 650kHz to 1.25MHz Bandwidth	Pitch Range	± 90°
		Roll Range	± 180°
Range	0.3 to 40 meters (1.25MHz) 0.3 to 80 meters (650kHz)	Accuracy	0.2°
Timing Accuracy	0.35mm (minimum)	Resolution	0.1°
Beam Angle	1° Conical (1.25MHz) 2° Conical (650kHz)		
Signalling	CW, CHIRP, IS ³		
Step Size	0.225°, 0.45°, 0.9°, 1.8°, 3.6° & 7.2°		
Scan Angle	360° Continuous or Sector Scan		

2.4 Communication, Power & Physical

Communications & Power		Physical	
Digital	RS232, RS485 & Ethernet	Weight (Air/Fresh Water)	0.88/0.31kg
		Depth Rating	4,000m
Protocol	9600 to 115,200 baud	Temperature	Operating: -10°C to 40°C Storage: -20°C to 60°C
Input Voltage	12 to 65V DC	Connector	Subconn MCBH8M-SS (other options available)
Power (Standby)	260mA @ 24V DC		
Power (Scanning)*	380mA @ 24V DC		

* Based on maximum power level and scanning speed

2.5 Acoustic Beam Pattern

The ISP360 profiler produces a conical acoustic beam which has been configured to provide optimal coverage for the purposes of underwater profiling.

The beam is 1° conical at 1,250kHz and 2° conical at 600kHz. The beam originates from the centre of the ISP360 transducer which is located 50mm from the top of the black acetal boot.

3.0 Installation

3.1 Electrical Installation

The ISP360 Profiler is fitted with a SubConn MCBH8M-SS connector as standard. This will mate to a SubConn MCIL8F connector/cable assembly and use a MCDLS locking collar. Other connector options are available upon request.

3.1.1 Connector Pin Out

The standard connector pinout is provided below:

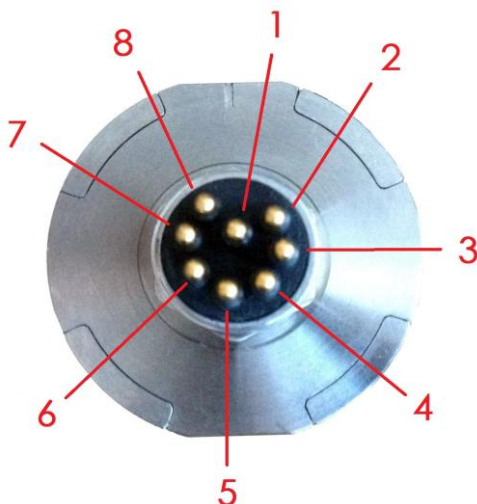

Male Connector on ISP360 Profiler

Pin	Function	Mating Wire Colour
1	0VDC (Power)	Black
2	12-65V DC	White
3	Ethernet TX-	Red
4	Ethernet TX+	Green
5	Ethernet RX- / Serial 0V	Orange
6	Ethernet RX+ / Serial 0V	Blue
7	RS232 TX & RS485 A+	White/Black
8	RS232 RX & RS485 B-	Red/Black

3.1.2 Power

The ISP360 Profiler can accept a DC voltage from 12 to 65V. Do not attempt to power the ISP360 with an input voltage out with this range and be sure to take into account voltage drop on any cable. To accommodate for in-rush current ensure a power supply with a power rating of at least 24W is used.

Note:

When powering, **the profiler should not be operated out of water** for long periods of time. Basic checks of operation can be performed out of water, but the sensor should be submerged once these are completed.

Note:

Do not reverse the polarity of the power input to the ISP360. The 0VDC input is shared with the Serial interface and Ethernet connection. Reversing the power input will result in permanent damage to the ISP360.

3.1.3 Serial Interface

The ISP360 has in-line fuse protection on the serial lines. A prolonged transient voltage on these lines will blow the surface mount fuses which will require replacement by Impact Subsea or an approved service agent.

3.1.4 RS232 Wiring

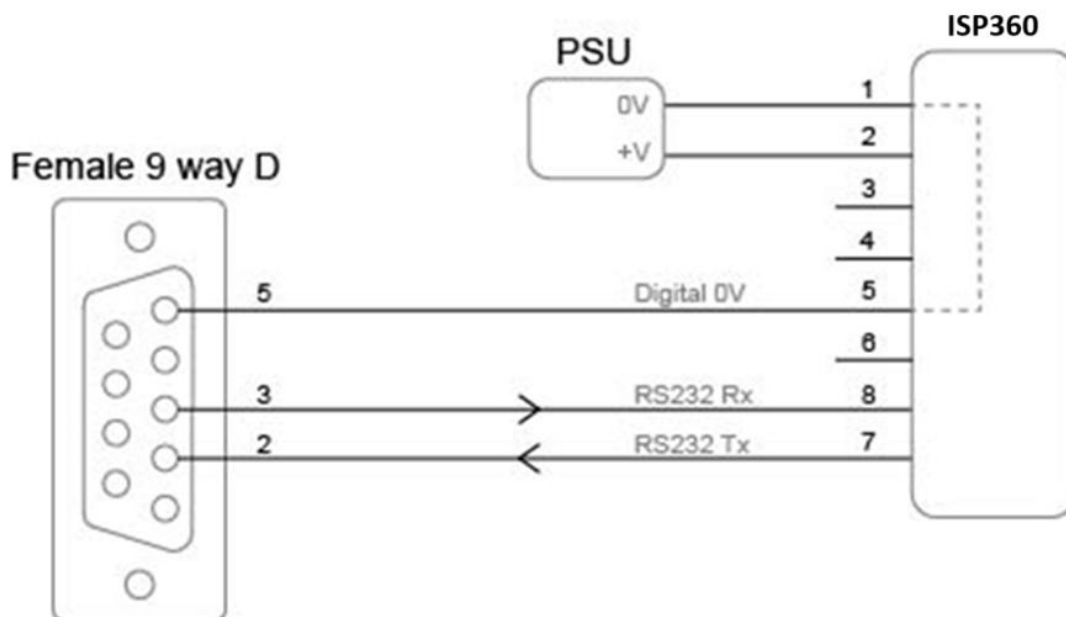

Note: RS232 will not function if the digital 0V pin is not used as the RS232 ground

3.1.5 RS485 Wiring

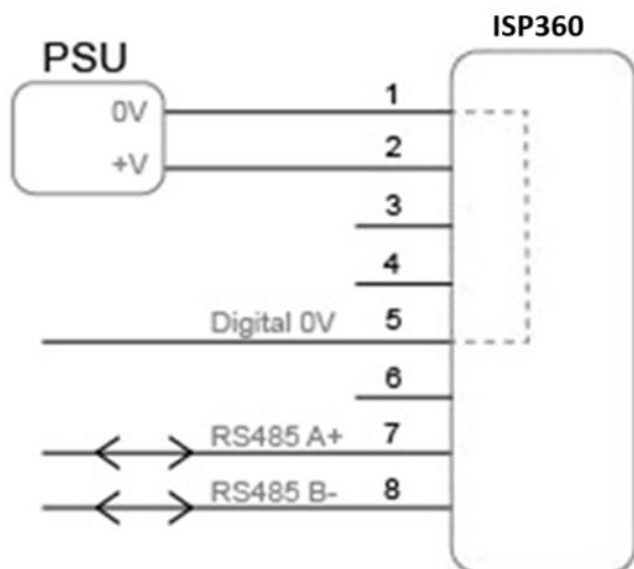

The digital 0V must be connected on an RS485 interface, otherwise the voltage potential between one of the A+ or B- lines to ground could reach a damaging level.

3.1.6 Ethernet Wiring

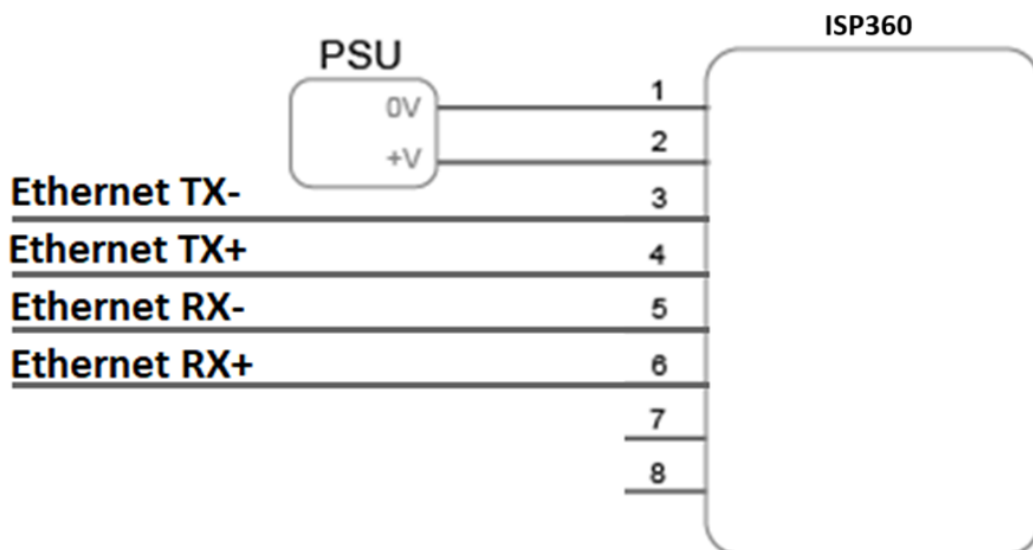

Note:

The ISP360 **cannot** be powered over an ethernet connection. Any attempt to use a power over ethernet connection will result in permanent damage to the ISP360.

3.1.7 Establishing Communications

The default dispatch serial settings are RS232, 115,200, N81.

If the profiler is tilted from vertical to upside down at least 3 times within the first 10 seconds of applying power then it will temporarily configure the serial interface to **RS232, 9600, N81** and output an ASCII message displaying the settings.



Inverting 6 times within the first 20 seconds of power up will temporarily configure the serial interface to **RS485, 9600, N81** and output an ASCII message displaying the settings.

Note: When the profiler is power cycled following this process, the serial interface setting will revert back to the last saved configuration.

3.1.8 Connector Mating

When mating the cable to the SubConn connector, to maximise the life of the connector, it is important to observe the following:

- Always apply grease before mating, Molykote 44 Medium grease must be used.
- Disconnect by pulling straight, not at an angle.
- Do not pull on the cable and avoid sharp bends at cable entry.
- Do not over-tighten the bulkhead nut.

Do not expose the connector to extended periods of heat or direct sunlight. If a connector becomes very dry, it should be soaked in fresh water before use.

3.1.9 Connector Cleaning

General cleaning and removal of any accumulated sand or mud on a connector should be performed using spray based cleaner (for example Isopropyl Alcohol). Avoid using strong cleaners such as contact cleaner.

New grease must be applied again prior to mating.

3.2 Installation Location

When evaluating the installation location of the profiler, there are several factors to consider to achieve optimum performance:

- Acoustics (For Profiling)
- Alignment with Vehicle (For Pitch/Roll)

3.2.1 Acoustics (Profiling Performance)

Of primary importance is the location of the profiler to achieve good profiling capability. The boot end of the profiler (*see diagram in section 2.1 for the ISP360*) requires to have a clear field of vision of the area to be profiled.

The boot end of the profiler contains a single transducer mounted on a stepper motor. This transducer moves through a 360° rotation in order to provide a 360° profile of the profiler's surroundings. The scan angle can be adjusted to narrow the area of coverage to suit the area which requires to be profiled.

When operating with a frequency of 1250kHz, the ISP360 has a 1° conical beam. When operating at a frequency of 650kHz the ISP360 has a 2° conical beam. It is therefore important to ensure that no part of the profiler mount/vehicle passes within this 1 or 2° beam. If it does, the part will be shown in the profiler data and may reduce range performance.

Ideally the ISP360 should not be operated in close proximity to other acoustic equipment with the same operational frequency (1250kHz or 650kHz). Other acoustic equipment within this frequency range may cause acoustic irregularities in the profiler data.

If required, the ISP360 operational frequency can be adjusted to move it out of band with other acoustic equipment.

3.2.2 Alignment with Vehicle

If installing the ISP360 under an ROV for seabed profiling, or internal pipe profiling, the profiler should be installed horizontally with the endcap marker facing downwards to the seabed:



The 6 o'clock position of the profiler head is about the notch marker on the endcap (circled in blue above). When defining a downward area for the ISP360 to scan over, it will be around this centre point.

It is important that the notch marker is installed pointing downwards. The position of the transducer is checked each time it passes this mark. This allows for automatic correction of any transducer slip (caused by an ROV impact or other shock).

If the ISP360 is not being used for seabed profiling, a vertical installation may be required instead (such as for in-tank profiling).

3.3 Mounting

The profiler should be mounted using clamps around the mid-section of the body. The body has a 20mm recess to allow a clamp to be tightened securely around the unit.



A non-metallic clamp should be used. In the event this is not possible, effort should be made to electrically isolate the clamp from the profiler housing. This can be achieved by using rubber or plastic strips around the body of the profiler.

Impact Subsea offer an acetal clamp as an optional accessory for the ISP360 (P/N: 2422) its dimensions are provided below:

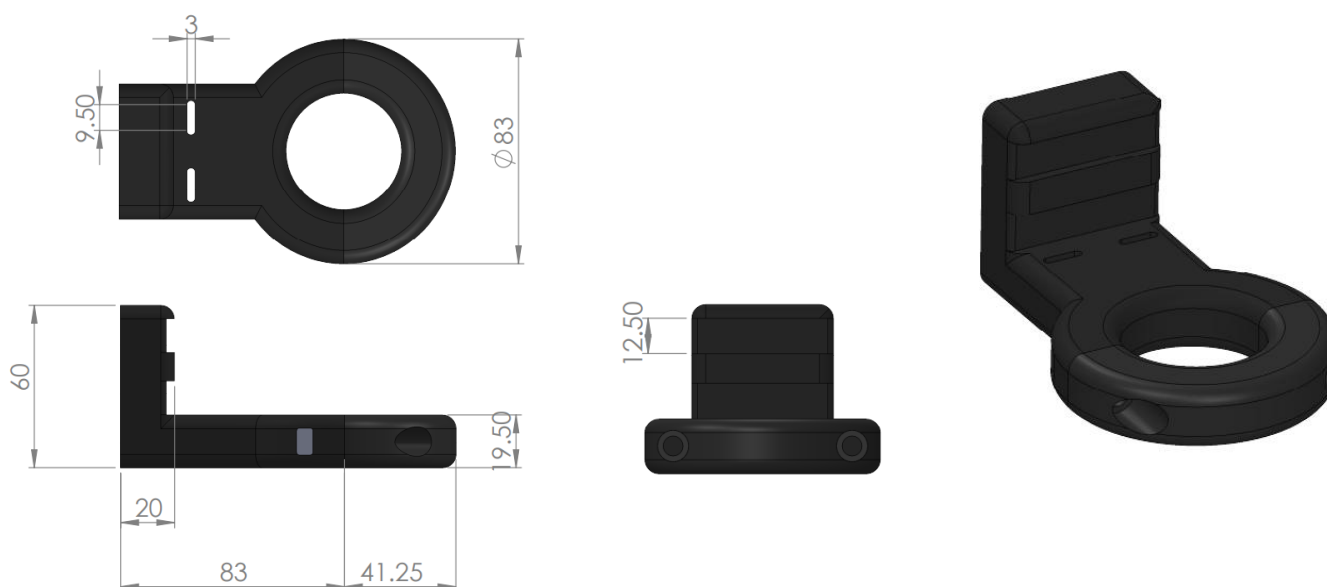

The profiler has two flats on either side of the connector endcap end of the body. These are to enable the unit to sit tightly against another flat surface if available. These flats also help prevent the profiler moving when on the workbench for testing.

Note:

Profiler Boot: The black boot end of the profiler is oil filled under vacuum to remove all air. **DO NOT** unscrew the boot from the profiler as the oil will escape and the profiler will require to be refilled with oil.

4.0 Operation

4.1 Use with seaView Software

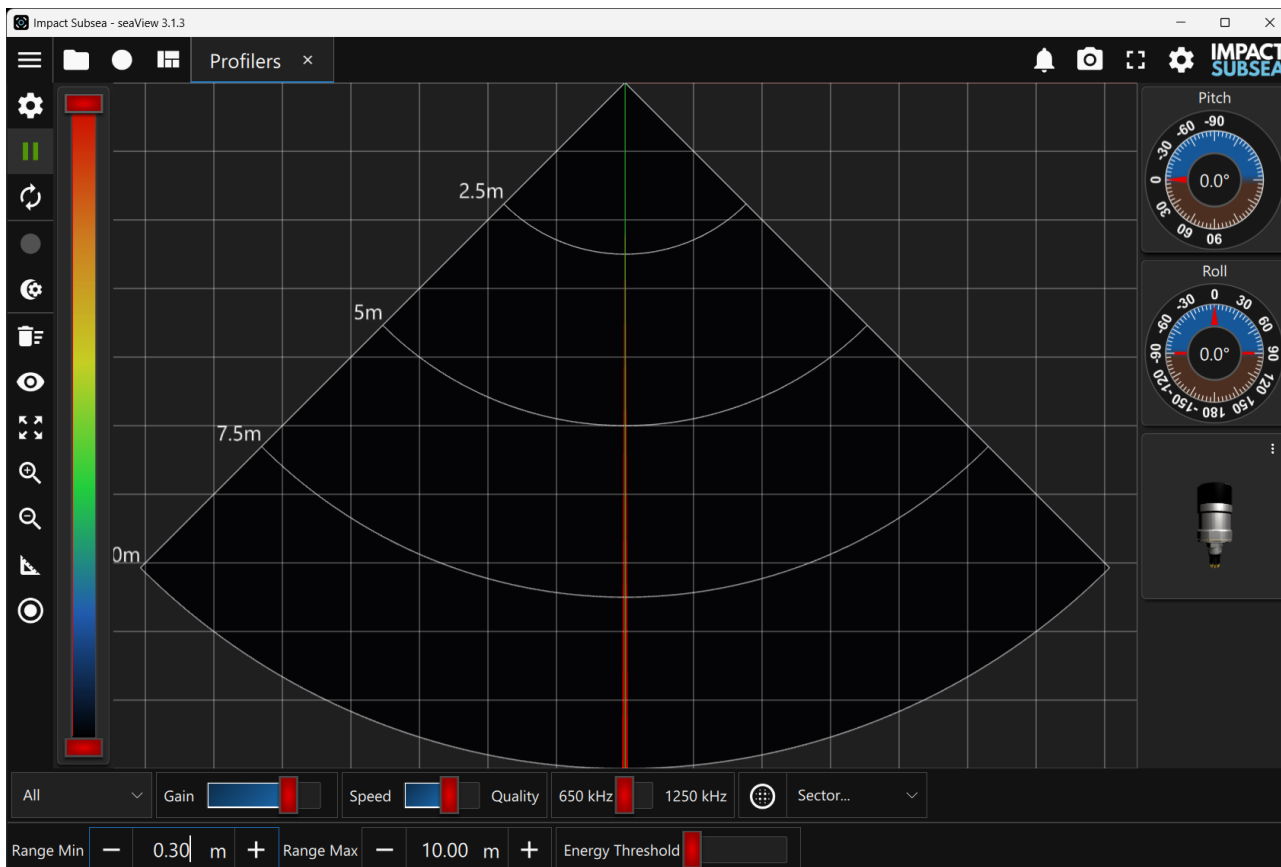

Shown above: seaView ISP360 Profiler Application

The profiler is supplied with the intuitive Impact Subsea seaView software on USB. The latest version of seaView can be downloaded from www.impactsubsea.com

seaView software works with all of the Impact Subsea range of underwater sensors. Single sensors can be operated or multiple sensors together.

For operation with the ISP360, seaView 3.1.3 or newer will be required. seaView is designed for use with a PC running the Windows 10 or 11, 64-bit operating system.

The ISP360 application within the seaView software has been designed to be highly intuitive and easy to use. For this reason, this manual only covers the core areas of the software to help the user obtain familiarity with the application upon first use.

4.1.1 Initial Connection

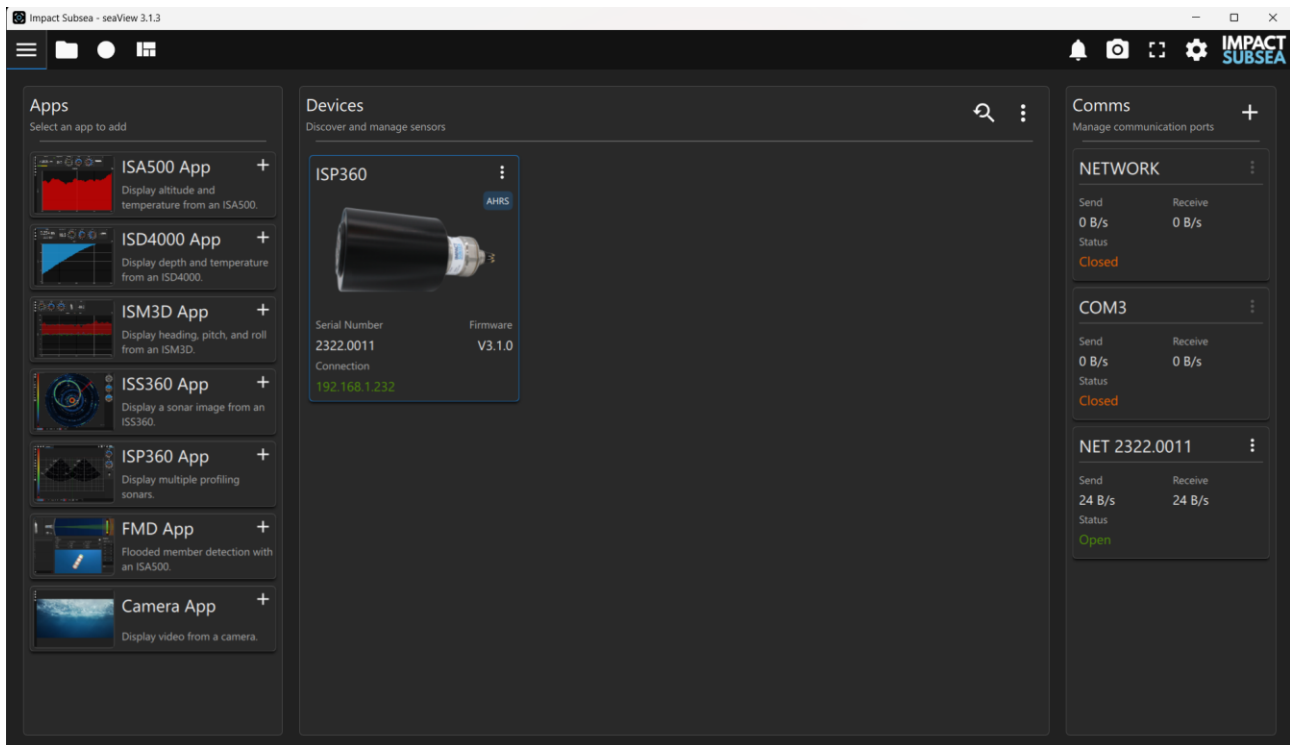

Shown above: Initial seaView launch screen

To begin, ensure the profiler is connected to the computer via RS232, RS485 or Ethernet communications and is powered on.

Upon launch of seaView, the software will automatically scan the available communication ports to detect the profiling sonar(s).

Once detected, the profiler will be displayed in the 'Devices' section in the centre of the display. In the above example, the ISP360 profiler with serial number 2322.0011 has been detected via an Ethernet connection and has an IP address of 192.168.1.232

Should a profiler be connected after launching seaView, the search button  should be pressed to search for the newly connected profiler.

Note:

Ethernet communications: If communicating via a network the ISP360 has DHCP enabled by default, so it will automatically be allocated an IP address on the network.

If running directly into a PC - allocate the PC a static IP address to enable communication. The default IP address of the ISP360 is 192.168.1.200. The PC should be configured to have a compatible IP address (for example 192.168.1.100).

Left click once on the profiler then click on the 'ISP360' app at the left-hand side of the screen. This will open the ISP360 profiler application.

4.1.2 ISP360 Profiler Application

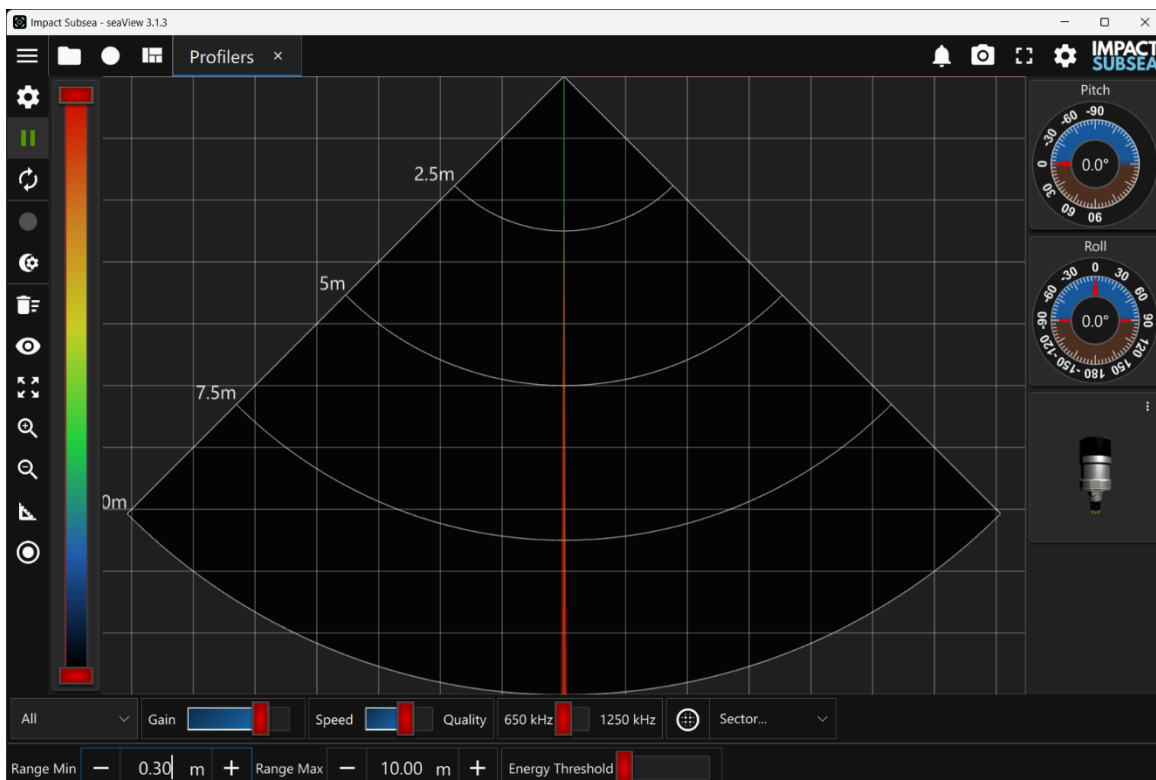

Shown above: ISP360 Application

Provided in this section is an overview of the key features of the application:

Colour Pallet:

To the left of the screen is the colour pallet selector, clicking on this will allow you to select various colour pallet options for the sonar data to be rendered in.

Raw Data:

The raw data returning from the sonar is presented as a red line overlaid onto the colour pallet:

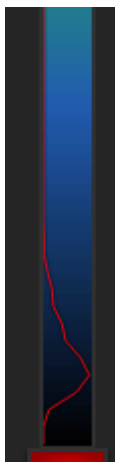

To ensure all data is plotted on screen, the colour pallet should cover all of the raw data being shown.

Image Threshold & Contrast:

Using the red handle on the upper and lower part of the colour pallet allows the sonar image data threshold and contrast to be adjusted.

This allows the sonar image to be adjusted to suit the requirements of the application at hand:

- Weaker targets can be removed from screen by raising the lowest red handle.
- Higher contrast can be provided by lowering the uppermost red handle.

Of note, this feature is only to adjust the sonar imagery – it does not adjust the threshold for the profiler data. Several examples of adjusting these variables on the same image are shown below:

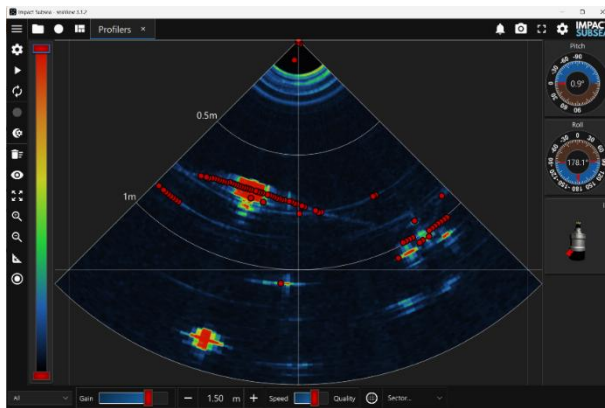

Standard setting – all data shown

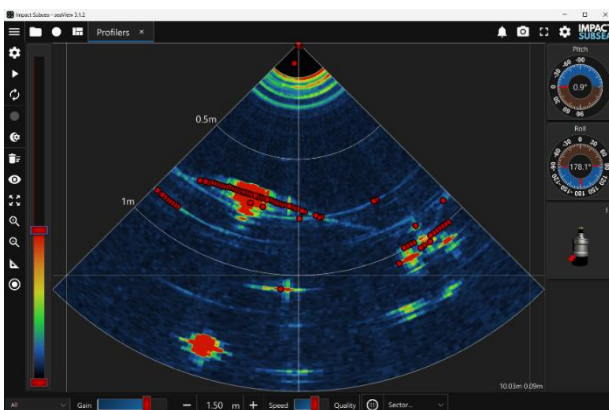

Upper Red Handle lowered - increasing contrast

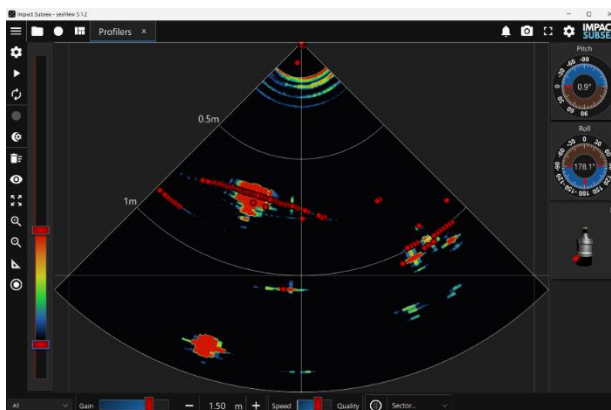

Lower Red Handle raised – removing weaker targets

Regular Access Controls:

Along the lower part of the screen, the controls which require most regular access are provided:



- **All/Individual Profiler**
 - Select which profiler to change settings of. Select 'All' to change settings on all Profilers operational within the application at the same time
- **Gain Slider**
 - The amount of amplification of the raw signal can be adjusted here. This is an on-screen amplification only – it does not alter settings within the profiler or the number of points generated.
- **Speed/Quality Slider**
 - The resolution and scanning speed of the profiler can be set here. There are six steps on the slider which correspond to the following transducer rotational step sizes: **7.2°**, **3.6°**, **1.8°**, **0.9°**, **0.45°** and **0.225°**.
 - **Speed:** Moving towards 'Speed' will enable a larger step size. This will increase the scan rate of the profiler and reduce the resolution – ideal for low resolution surveys
 - **Quality:** Moving towards 'Quality' will enable a smaller step size. This will increase the resolution of the sonar image and decrease the scan rate – ideal for high resolution surveys.
- **Frequency**
 - This button allows the frequency to be toggled between 650kHz and 1250kHz. The 650kHz will have a 2° conical beam and long range. The 1250kHz will have a 1° beam and shorter range. For the highest resolution of data, the 1250kHz frequency should be used.

- **Bins/Sector**

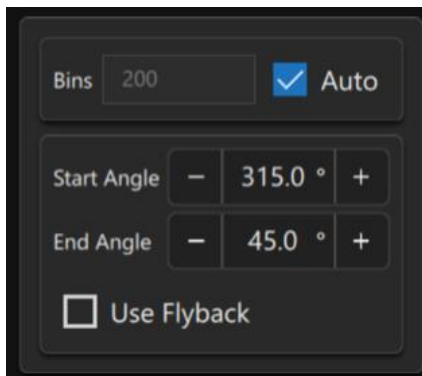
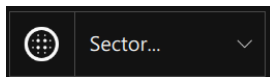

'Bins' allows selection of how many samples are taken over the selected range for each ping. When **'Auto'** is selected, this is locked to the number of pixels available to display readings from each ping (one reading per pixel). Un-checking this tick box will allow the bins to be manually increased or decreased. Bins are only for the creation of imagery data – they do not affect the resolution of accuracy of the profiler points generated.

The **'Start'** and **'End'** angles set the scan sector of the profiler.

The **'Use Flyback'** tickbox enables flyback on the transducer. When enabled, pings will be generated when scanning clockwise and then the transducer will 'fly' back to the starting position without pinging and begin scanning the next sector. If disabled, the scan will ping in both directions (IE from the start angle to the end angle and back again).

The drop down **'Sector'** box allows quick selection of the common scan sectors which are used.

- **Range Min**

- This is the distance at which the ISP360 will start to generate profiler points. Any items below this range will not be profiled.

- **Range Max**

- This is the maximum distance that the ISP360 will measure to. Reducing this range to the minimum required will enable faster data generation.

- **Energy Threshold**

- This allows a threshold to be set on the points which are being profiled. The threshold works on the amplitude of the returning acoustic reflection. An Energy Threshold of zero will allow all returns to be used as profiler points. As you move the threshold up, the weaker returns will no longer be converted into profiler points.

The energy threshold allows the removal of noisy data and is to be adjusted to suit survey preference.

4.1.3 ISP360 Operational Settings

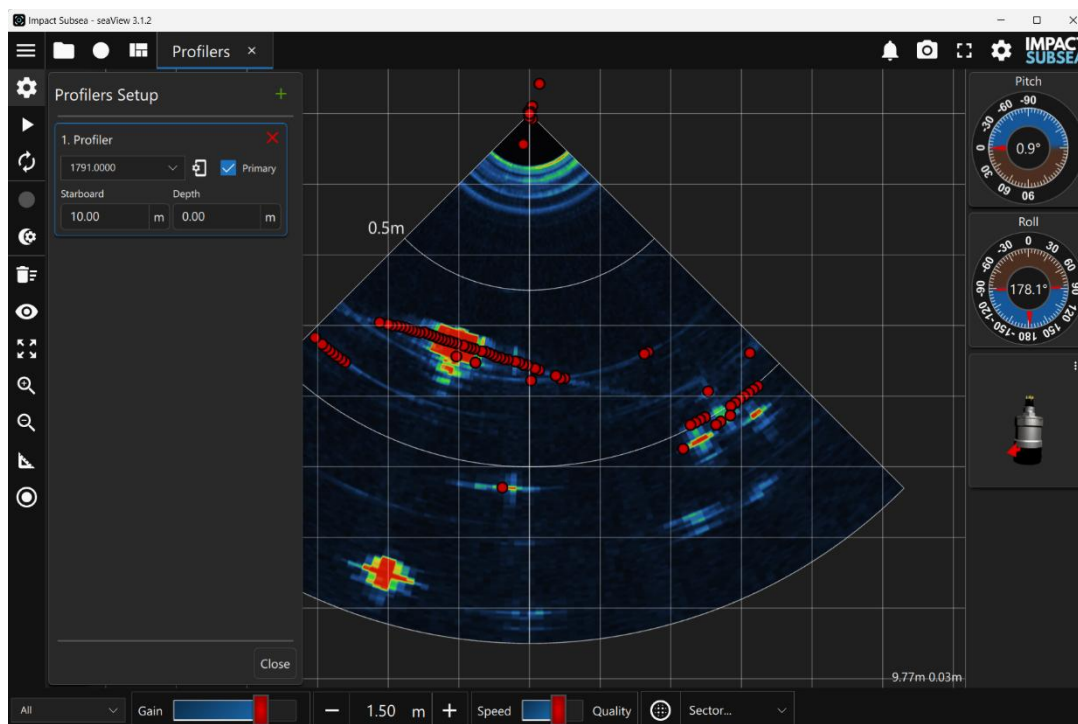

Shown above: ISP360 Setup

Clicking the  Setup icon will allow access to the operational settings of the profiler.

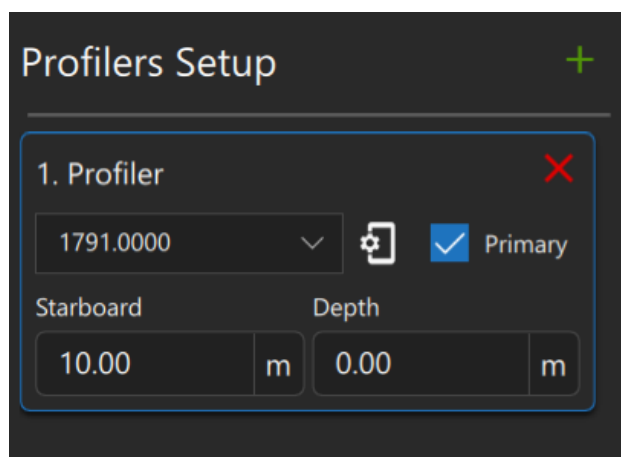

Shown above: ISP360 Setup

In this tab, profilers can be connected and removed from the application. Clicking the green + sign will allow further profilers to be added.

Any physical offsets of the profiler on the vehicle or other installation can be entered here – these will be reflected on the display.

Clicking on the  icon within the profiler setup will enter the settings of the selected profiler:

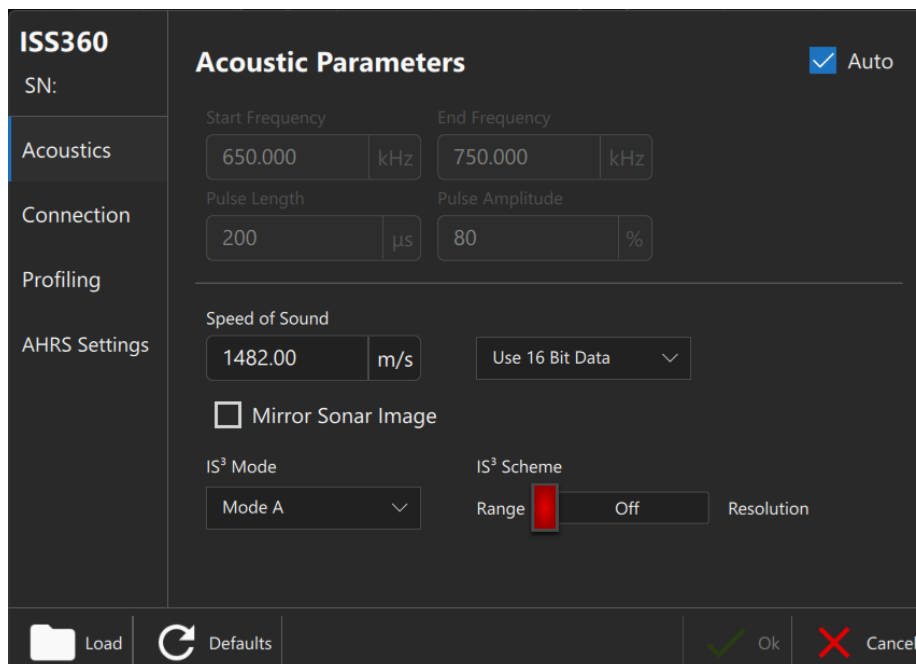

Shown above: ISP360 Acoustic Settings

The Acoustic settings tab allows the **‘Speed of Sound’** to be entered.

‘Use 16 Bit Data’ or **‘Use 8 Bit Data’** can also be selected – if there are bandwidth limitations reducing the data to 8 bit values will enable faster scanning.

‘Mirror Sonar Image’ should be selected if the profiler has been installed in the reverse of its default installation orientation. The default orientation is Boot Up for vertical profiler and profiler on its side with Endcap North Marker facing Down for horizontal profiling.

By default the **‘Auto’** button will be selected for the Acoustic settings. This will allow the ISP360 to automatically adjust the acoustic settings for optimum performance at all ranges. Should you wish to disable this feature you can do so by un-ticking the **‘Auto’** button. This will then allow the **‘Start Frequency’**, **‘End Frequency’**, **‘Pulse Length’** and **‘Pulse Amplitude’** to be adjusted. Un-ticking the ‘Auto’ settings will also allow a custom frequency to be configured in the range 600kHz to 1,250kHz.

‘IS³ Mode’ allows selection of **‘Mode A’** or **‘Mode B’**. When running a pair of ISP360 profilers, one profiler should be set to **‘Mode A’** and the other to **‘Mode B’**. This will ensure that alternative signalling codes are used to minimise interference between the two profilers.

‘IS³ Scheme’ allows the selection of four different IS³ code lengths. The longer codes will provide a higher range resolution of data. The shorter codes will provide a longer range capability. If set to ‘Off’ the IS³ Signalling will be turned off and the ISP360 will work on continuous wave acoustics.

ISS360
SN: 1791.0000

Acoustics

Connection

Profiling

AHRS Settings

Serial

Mode: RS232 | Baud Rate: 115200

Network

IP Address: 192.168.1.240 | Netmask: 255.255.255.0 | Gateway: 192.168.1.1

Use DHCP: | Connection Mode: 10-Base Half | MDIX Mode: Auto

Load | Defaults | Ok | Cancel

Shown above: ISP360 Connection Settings

In the Connection tab the serial mode of the profiler (RS232, RS485 or RS485 Terminated) can be configured along with the desired baud rate.

The Network configuration of the profiler can also be configured here.

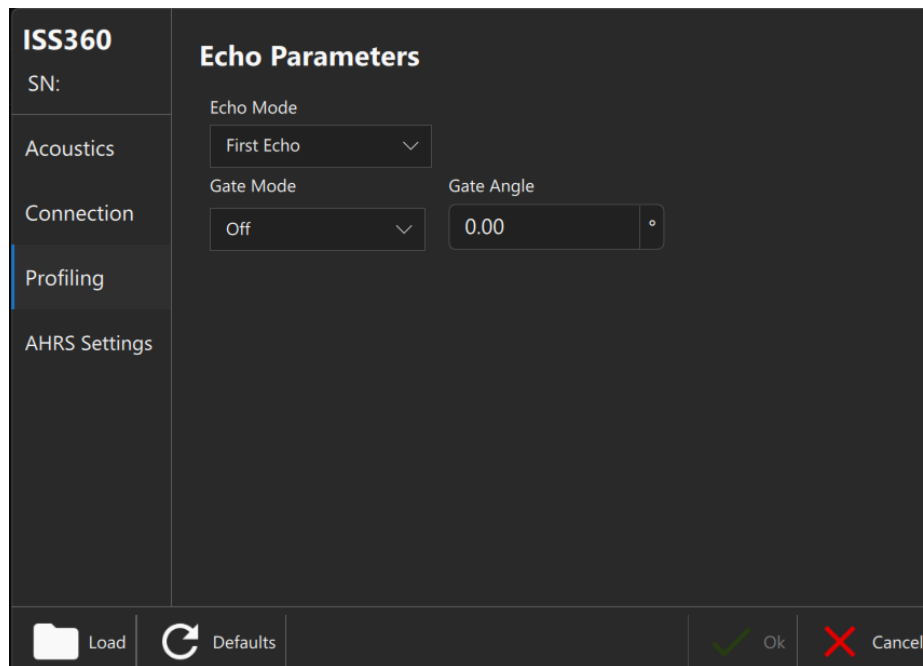

Shown above: ISP360 Profiling Settings

The Profiling Tab allows adjustment of core profiling parameters.

The **'Echo Mode'** allows selection of which Echo for the profiler to trigger on:

- **'First Echo'** will trigger on the first echo returned to the profiler. This will be a single range reading per bearing output.
- **'Strongest Echo'** will consider all of the returned acoustic echoes from across the configured measurement min and max ranges and select the one with the largest amplitude to trigger on. This will be a single range reading per bearing output.

The **'Gate Mode'** allows depth/range gating to be turned on or off.

Gating allows the ISP360 to complete sector scans more quickly, by using a range for the depth and extending the measurement range as pings are made off centre of the scan sector.

For example, setting a range to 10 meters with gating turned off will result in each ping measuring for the complete 10 meters. This might be necessary to cover the sector and achieve the required range at the extremities. An alternative is to set a shorter range (say 7 meters) with gating turned on. This will extend the ISP360 measurement range automatically to maintain a relative 7 meters height. The Gate angle defines the angle of plane relative to the ISP360 notch marker to gate to.

Roll Compensation will turn Gating on and use the ISP360 Pitch/Roll readings to compensate for roll of the sensor.



Shown above: ISP360 AHRS Settings

This page allows the configuration of how the sensor has been physically installed on the vehicle or other deployment method.

The dropdown menu at the top allows quick selection of the orientation – this will be reflected in the ROV mimic on the right. For the majority of horizontal profiling applications, **'Pitch -90'** should be selected. This will have the endcap north marker pointing in the direction of the seabed. **'Default'** or **'Invert'** will be required for vertical profiling applications.

If there have been any minor mis-alignments during the installation, these can be entered in the **'Heading'**, **'Pitch'** and **'Roll'** boxes. The adjustment scale can also be selected here. Entering of values here will allow the Pitch and Roll values output by the profiler to be correct to the vehicle/other deployment mechanism reference.

The **'Turns Counter'** dropdown box allows selection of the Pitch or Roll to count turns around.

The **'Data Rates'** button allows the update rate to be set for each of the MEMS based internal sensors within the profiler.

4.1.6 Other Settings & Logging

On the left-hand side are further controls for the sonar:

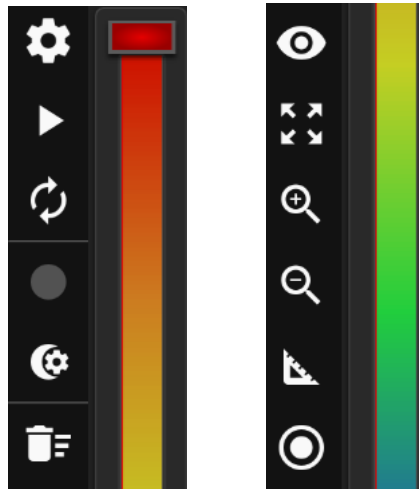



The Run/Pause button  will start the profiler scanning. Pressing again will stop scanning.

The Scan Direction button  will change the direction which the profiler scans (clockwise or counter-clockwise).

The start logging/output button  will enable/disable the profiler log file creation or data output.

The logging/output configuration button  will allow creation of a log format or selection/creation of an output string.

The Clear Image button  will erase all profiler data currently on the display, providing a blank profiler screen.

The Display Options button  allows a number of items on the profiler display to be edited:

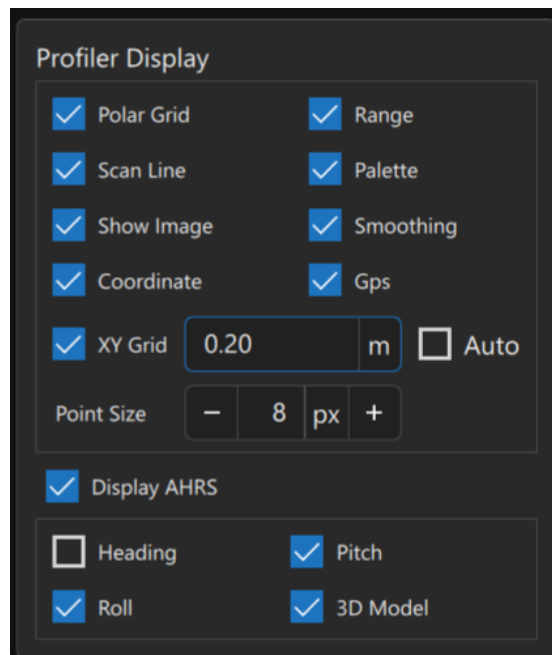

Shown above: ISP360 AHRS Settings

- **'Polar Grid'** – turns on/off the overlay on the profiler display
- **'Scan Line'** – turns on/off the red scan line showing the position of the profiler transducer
- **'Show Image'** – turns on/off the sonar imagery
- **'Coordinate'** – turns on/off the coordinate readout in the lower right hand corner
- **'XY Grid'** – overlays a grid over the profiler data. The grid side can be set here or set to Auto scale with the range configured
- **'Point Size'** – allows the profiler data points to be adjusted in size on screen in pixels
- **'Range'** – turns on/off the range readings on the profiler data
- **'Palett'** – turns on/off the pallet display on the left of the screen
- **'Smoothing'** – turns on/off the smoothing of the sonar imagery
- **'Gps'** – turns on/off the GPS display (available when there is a GPS input to seaView)
- **'Display AHRS'** – turns on/off the Pitch/Roll/3D model of the profiler on the right-hand side
 - Individual readouts can also be configured to be viewable on the display



The Reset View button will restore the profiler display to full screen. This is useful if you want to quickly zoom out of a zoomed area of the profiler display.



The Zoom In and Zoom Out buttons allow sections of the profiler display to be magnified. Once zoomed in, clicking and holding the left mouse button will allow the area of zoom to be moved around the display. The display can also be zoomed into or out of by using the mouse wheel or by pinching the screen if using a touchscreen display.



The Measurement button allows on-screen measurements to be made. Clicking the button and then clicking on the display and dragging the ruler will provide an on-screen measurement as shown:

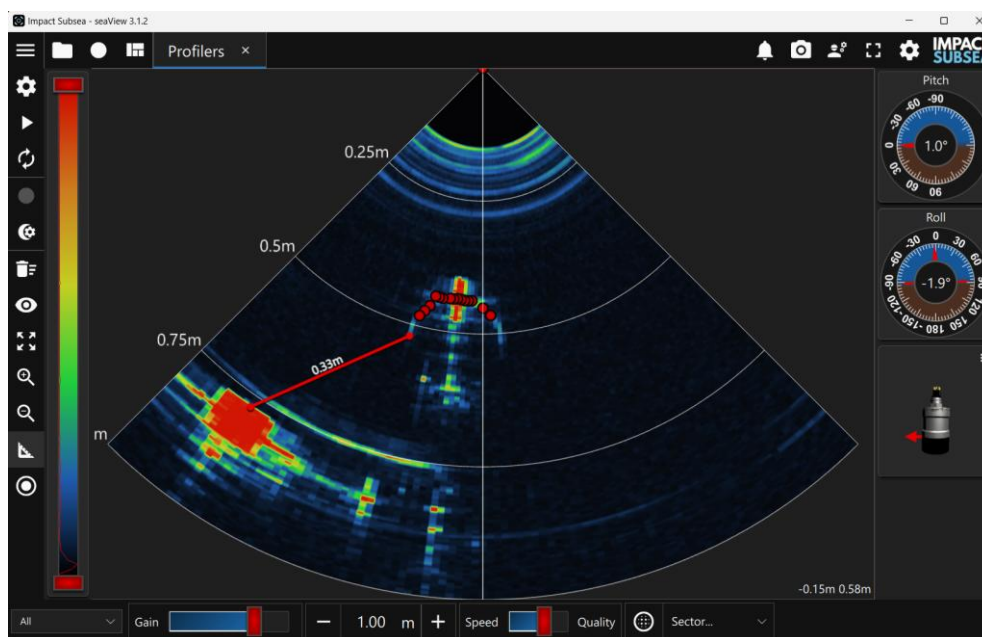

Shown above: Measurement tool in use

The Pipe tool  allows a pipe to be placed on screen. This is helpful to visualise the placement of the pipe under the profiler, or between a pair of profilers:

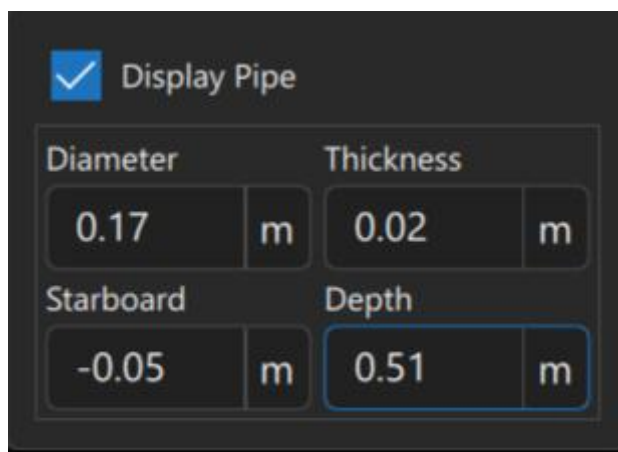

<input checked="" type="checkbox"/> Display Pipe			
Diameter		Thickness	
0.17	m	0.02	m
Starboard		Depth	
-0.05	m	0.51	m

Shown above: Pipe setup

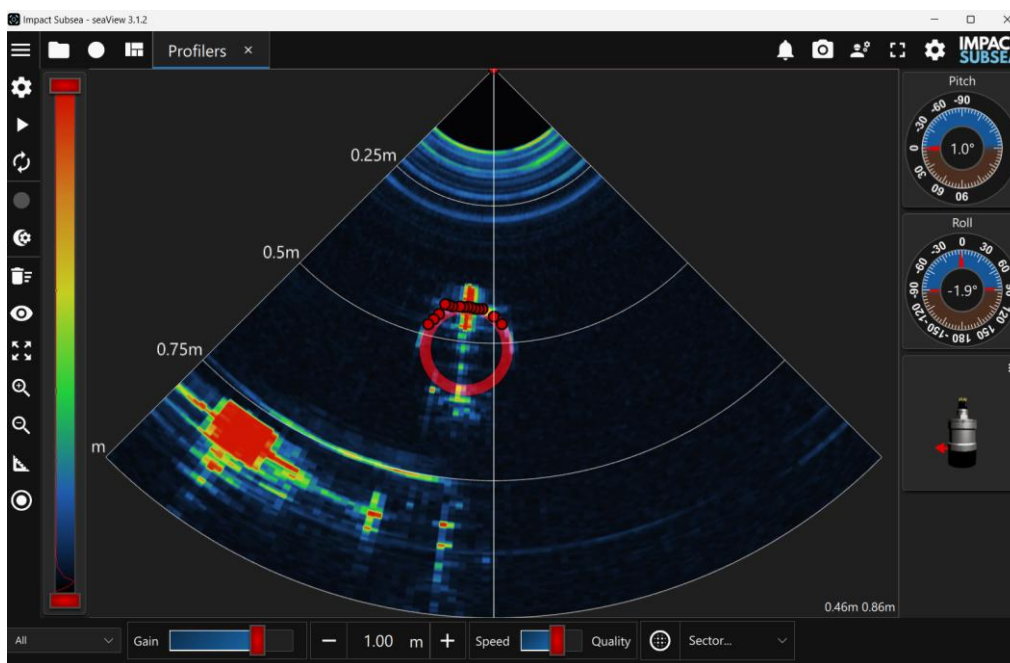

The setup allows the diameter of the pipe, wall thickness, and position information to be entered. The above pipe setup results in the pipe shown below being placed onto the profiler imagery:



Shown above: Pipe overlaid on sonar/profiler data

Along the top left the following icons are present:





The Record Log button  will allow you to configure and start a log file of the profiler data. This is the Impact Subsea propriety format for replay within seaView. The Open Log button  will allow previously logged data to be played back.

The View Layout button  will allow multiple sensors to be displayed on screen at the same time, instead of having individual tabs for each sensor.

Along the top right the following icons are present:



The notifications button  will display a list of any notifications from seaView.

The screenshot button  will save a screengrab of the application.

The Full Screen button  will put the application into full screen mode.

Clicking on the Impact Subsea logo will take you to the Impact Subsea website – ideal for downloading the latest version of the seaView software or accessing other technical information.

The system settings can be accessed by clicking on the  button. The system settings allow the default logging and screenshot locations to be configured. Units can be switched from Metric to Imperial. Any system licenses can be installed here (such as FMD licenses). The dark/light modes can be toggled and the application font size adjusted. Details on the software version are also available under this section.

4.1.7 Data Output to Survey / Custom Log File

The start logging/output button  will enable/disable the profiler log file creation or data output.

The logging/output configuration button  will allow creation of a log format or selection/creation of an output string.

Clicking on the configuration button will present the following screen:

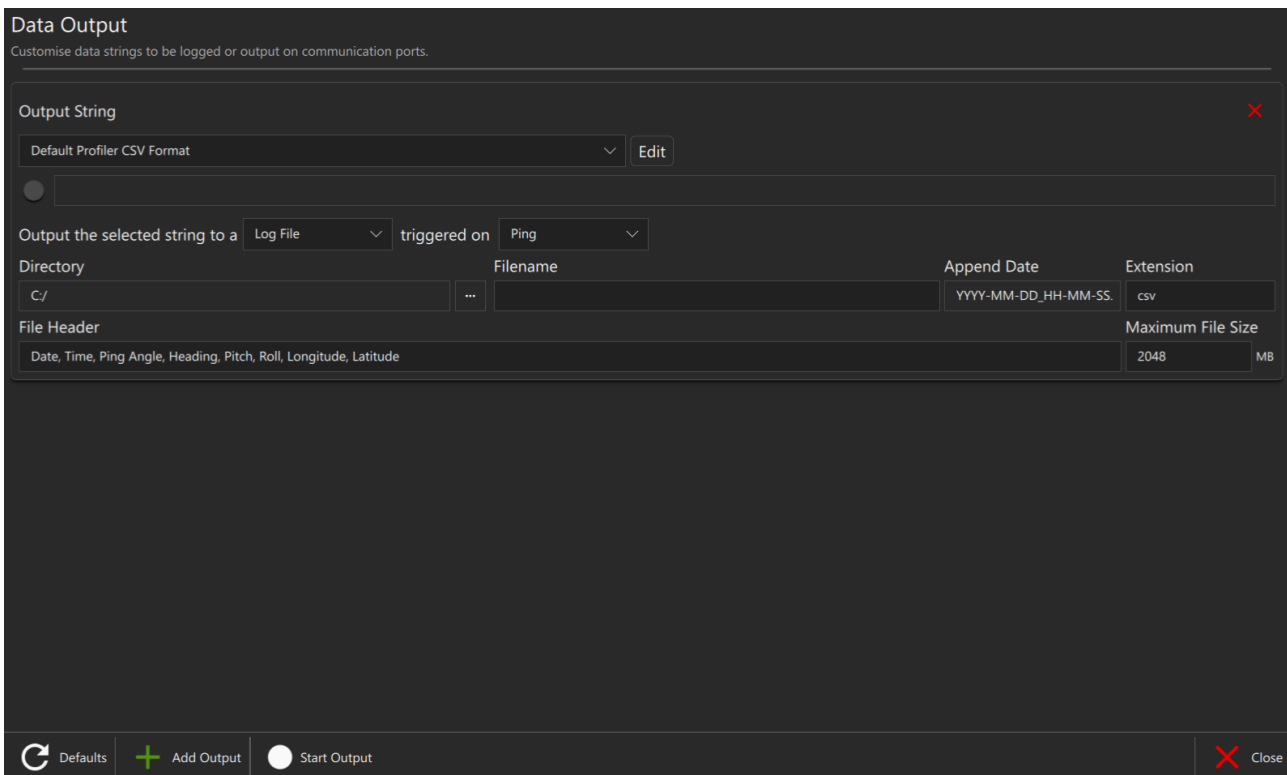

Shown above: Configuration of output string or custom log file

The required output string can be selected from the dropdown box. The standard output strings can be found in Section 6 of this manual.

The output location (either a file or a COM Port) can be selected.

One output can be generated or multiple outputs (such as having one log to a file, another on a com port to survey software etc).

The string output can also be started and stopped from this window.

4.1.8 ISP360 Acoustic Advanced Features

Some serial output strings for distance measurement report back the energy level of the echo and also a correlation factor.

The energy level ranges from 0 to 1 where 1 represents full saturation of the ISP360 receiver. An energy level of 0.707 (square root of 2) is the theoretical perfect level as it represents the energy of a pure sine wave with an amplitude utilising the maximum dynamic range of the ISP360.

The correlation factor ranges from 0 to 1 which represents a quality factor of the returned echo. A value of 1 would represent a return echo of perfection with negligible noise and distortion.

The correlation value can be used alone as a trust factor where low values such as 0.3 mean there a good possibility it's a false reading. A more detailed picture can be built by combining this information with the energy level as shown in the table:

	Low energy levels	High energy levels
Low correlation	Weak signal probably false reading	High noise level most likely a false reading
High correlation	Weak signal but likely a good reading	Ideal conditions very trust worthy readings

These values can also give some insight for adjusting the transmit power. If the energy level is low then consider increasing the amplitude and/or the length of the transmit pulse.

4.1.9 Hot Keys

Full Screen:

Pressing the F11 key will activate full screen mode in seaView. Pressing again will deactivate – this can be useful to ensure you maximise the screen space available for the sonar display.

5.0 Maintenance & Servicing

The ISP360 is a highly robust Profiler which has been designed to require minimal maintenance. Due to this there are no user serviceable components.

Following use, the profiler should be rinsed in fresh water to remove particles and salt deposits. If required a light detergent (such as that used to clean household dishes) can be used.

DO NOT USE SOLVENTS TO CLEAN THE UNIT

Following rinsing, the sonar should be dried with a cloth.

The connector should be cleaned and a light coating of Molykote 44 Medium grease should be applied.

The profiler should be stored in its original case, in a cool, dry place.

It is recommended that the profiler be returned to Impact Subsea Ltd, on an annual basis to have a health check and service conducted.

6.0 Output Strings

Due to the close integration of the ISP360 and seaView, all data collected from the ISP360 requires to be output from seaView. It is not possible to configure the ISP360 to directly output data in stand alone use (no seaView connected)

The below are some default output strings available as an output from the ISP360 via seaView. These can be selected from the drop down 'Output String' box. Of note, customer ASCII output strings can be created using the seaView string editor. This enables virtually any configuration of string to be created.

Impact Subsea Profiler

```
$ISPR1,pppp.nnnn,s,us,a,f.fff,c.ccc,e.eee*xx<CR><LF>
```

<i>pppp</i>	Profiler part number
<i>nnnn</i>	Profiler serial number
<i>s</i>	Ping timestamp in seconds since the Unix epoch 1 st January 1970, UTC time
<i>us</i>	Ping timestamp remaining microseconds
<i>a</i>	Ping angle in units of 12800 or 1/32 gradians
<i>f.fff</i>	Ping time of flight in milliseconds to target and back
<i>c.ccc</i>	Ping correlation
<i>e.eee</i>	Ping energy
<i>xx</i>	NMEA standard checksum

Numbers left of the decimal point are variable length, right of the decimal point is three (3) digits.

Tritech Profiler Format

An emulation of the Tritech profiler output.

7.0 Theory of Operation

7.1 Sonar – Basic Principles

The ISP360 is a mechanically scanning profiling SONAR (SOund NAvigation and Ranging).

This is an active profiling sonar which operates by transmitting a pulse of sound into the water; then listening for and plotting the returned echoes that are reflected by items in the water.

The ISP360 profiler emits a pulse of sound which is 1° conical (at 1250kHz) and 2° conical at 650kHz. Any item which falls within this pulse of sound will be detected and plotted on screen.

The profile image is built up by rotating a transducer in the boot end. The transducer emits a pulse of sound (a 'Ping') and listens for any returning echoes across the defined measurement range. Once complete, the transducer is rotated by a step (size defined in the software) and the process repeats.

Through the 'Ping', 'Listen', 'Step' processes: a 2D, top-down image/profile is produced on screen.

There are a number of books and resources available online which explore sonar image interpretation in detail. It is assumed the user of the ISP360 is familiar with basic sonar image interpretation, so detail is not provided here.

Acoustics (also known as hydro-acoustics, or sound pressure waves) are used by the ISP360 Profiler due to their high efficiency in travelling long distances through water. Through-water acoustics can travel far greater distances than signals in the light or radio frequency spectrum. Thus, are the ideal method to use for visualising the underwater environment.

The profiler operates by emitting an acoustic pulse into the water. This pulse travels through the water until it comes into contact with the seabed or other objects. Upon contact with the seabed/objects, part of the pulse is absorbed, and part is reflected back to the profiler.

This reflected portion is detected by the profiler and the time taken for this acoustic pulse to travel from the profiler, bounce off the seabed and return is recorded.

The distance the acoustic pulse has travelled can then be calculated by this simple equation:

$$\textit{Distance} = \textit{Speed} \times \textit{Time}$$

In water, the speed of sound is typically around 1,500 meters per second. This is influenced by various factors (temperature, salinity & pressure). However, for the purpose of this explanation, we will assume a speed of sound of 1,500m/s.

If an acoustic pulse takes 0.1 second to return to the ISP360 sonar after being sent, we can calculate its round-trip travel distance as:

$$\begin{aligned}\textit{Distance} &= \textit{Speed} \times \textit{Time} \\ &= 1,500 \times 0.1 \\ &= 150\textit{m}\end{aligned}$$

Therefore, the total distance the sound has travelled is 150m (journey to the object + journey back from the seabed).

To calculate the distance, we simply half this value. I.E. the range to target is 75m.

The target would then be plotted on screen at a range of 75 meters.

7.2 The Sonar Equation

Any equipment which relies on underwater acoustics for ranging purposes falls into the category of a Sonar, hence the operation is governed by the 'Sonar Equation'.

A clear understanding of this Equation is essential in the design of any acoustic equipment, and is useful for those wishing to utilise acoustic equipment to its full potential.

The Sonar Equation is a fundamental equation, which is at the heart of all hydro-acoustic systems:

$$SL - TL - (NL - DI) > DT$$

SL = Source Level

TL = Transmission Loss

NL = Noise Level

DI = Directional Index

DT = Detection Threshold

7.2.1 Source Level (SL)

The Source level is the power at which the acoustic pulse is put into the water. A greater source level will increase the range capability; however, it will also increase the power consumption.

Therefore, a trade-off between power consumption of the device and the range required must be achieved.

There is also a physical limit to the Source Level; which can be achieved underwater before cavitation occurs, and acoustic transmission breaks down.

7.2.2 Transmission Loss (TL)

As the acoustic pulse propagates through the water, it experiences spreading. This causes the energy of the signal to be dispersed over an ever-increasing area, diminishing the energy at any specific point as distance increases.

The acoustic pulse will also experience absorption by the water. The rate at which the acoustic pulse is absorbed is directly related to the pulse frequency. The higher the frequency, the higher the absorption rate.

However, typically the higher the frequency, the higher the acoustic resolution can be achieved. Thus, another trade-off must be made: to use the highest frequency possible, while achieving the desired range capability.

7.2.3 Noise Level (NL)

Noise level is environment specific; which can often be the reason for acoustic systems experiencing different levels of performance in different locations, or even when operating at different times.

There are numerous sources that contribute to the background noise level underwater. All of which make the detection of the return acoustic signal increasingly more difficult.

From an environmental perspective, marine life such as snapping shrimp can cause a reasonable level of noise. Also, wind and rain can be a factor if operating close to the water surface.

Man-made sources of noise include those from machinery – such as vessel noise (thrusters and props), and also noise from ROVs and AUVs.

Multipath effects can also add to the background noise. If operating acoustic equipment in an enclosed area/close to a structure, the acoustic signals tend to 'bounce around' which can cause sporadic operation of acoustic equipment.

In the case of profiling sonar, multipath can sometimes cause faint mirrored images of targets.

7.2.4 Directional Index (DI)

The Directional Index gives a reduction in noise level, governed by the properties of the transmit/receive transducer.

An omni-directional transducer will theoretically pick-up noise from all directions. A directional transducer will hear noise from only one direction. Thus, a method of reducing the apparent background noise is to utilise a highly directional transducer.

The ISP360 sonar utilises a 1° to 2° conical beam. Meaning that any potential interference effects, which exist outside of this beam, will not have a negative impact on the operation of the unit.

7.2.5 Detection Threshold (DT)

The Detection Threshold is a property of the acoustic system. It is defined as the minimal signal to noise ratio required in order to detect the acoustic signal.

The threshold can be lowered by minimising the device self-generated noise: utilising advanced acoustic signalling, whilst having a highly capable matching filter or a highly sensitive transducer on the receive side to detect the signal.

The ISP360 profiler utilises a proprietary acoustic correlator to detect the returning acoustic signal, low noise digital electronics and a highly sensitive composite transducer to enable it to detect extremely small acoustic signals.

An appreciation of the Sonar equation will provide an understanding of the fundamental operation of the ISP360 profiler. It may help during installation and fault-finding, as it provides an indication to influential factors.

8.0 Warranty

The ISP360 is supplied with a Limited Warranty. This warranty applies solely to the ISP360 and only if purchased directly from Impact Subsea Ltd.

What does the limited warranty cover?

This Limited Warranty covers any defects in material or workmanship under normal use during the Warranty Period.

During the Warranty Period, Impact Subsea Ltd will repair or replace products, or part of a product (under normal use and maintenance), that prove defective due to improper material or workmanship.

What will we do to correct the problems?

Impact Subsea Ltd will either replace or repair the Product at no charge: using new or refurbished replacement parts. Replacement or repair is at the discretion of Impact Subsea Ltd.

How long does the coverage last?

The Warranty Period for the ISP360, purchased from Impact Subsea Ltd, is 1 year from the date of dispatch from Impact Subsea Ltd.

A replacement ISP360, or part, assumes the remaining warranty of the original Sonar or 60 days from the replacement/repair, whichever is longer.

What does this limited warranty not cover?

This limited warranty does not cover any problem that is caused by conditions, malfunctions or damage resulting from defects in material or workmanship.

What do you have to do?

To obtain a warranty repair of your ISP360, you must first contact Impact Subsea Support to determine the problem and the most appropriate solution for you.

9.0 Technical Support

Should you require technical support for your ISP360 Profiler, our Support team can be contacted as follows:

- T.** +44 (0) 1224 460 850
- E.** support@impactsubsea.co.uk
- W.** www.impactsubsea.com

An out of hours emergency number is available via the Impact Subsea website.

Utilising the above email address will ensure that a number of support engineers are copied into your support request, and will ensure a prompt response.

When contacting our Support team, please provide the following details of the ISP360:

- Serial Number
- Firmware version
- Software version
- Fault Description
- Remedial action undertaken thus far

Every effort is made to ensure that information within this document is up to date. However, information within this document is subject to change without notice, in-line with our commitment to continuous product development and improvement.